

C-799 B



NEW LUXURY HOUSE IN EL MOLINAR
WITH ROOF TERRACE, SEA VIEWS
AND POOL



€ 2.400.000,00 €

Palma de Mallorca

3

3

ca. 196 m²

ca. 240 m²

NUEVA CASA DE LUJO EN EL MOLINAR
CON TERRAZA, VISTAS AL MAR Y
PISCINA

NEUES LUXUSHAUS IN EL MOLINAR MIT
DACHTERRASSE, MEERBLICK UND
POOL

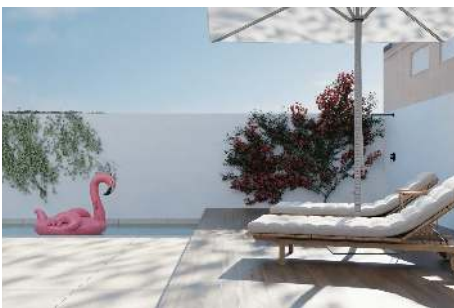

WWW.BCONNECTEDMALLORCA.COM
PLAÇA ESPANYA 3, 07181 PORTALS NOUS, SPAIN
T.: +34 971 221 066
REALESTATE@BCONNECTEDMALLORCA.COM

We reserve the right to change prices without prior notice
Nos reservamos el derecho a cambiar los precios sin previo
aviso. Wir reservieren uns das Recht die Preise zu verändern
ohne vorherige Nachricht.

NEW LUXURY HOUSE IN EL MOLINAR WITH ROOF TERRACE, SEA VIEWS AND POOL

For sure the Molinar area is one of the most sought after in Mallorca. Very close to the airport, just a hop to Palma you enjoy tranquility only few meters away from the sandy beach of Molinar.

This amazing new property is just a 5 minutes walk away from the fantastic new built harbour. The whole area is full of amazing restaurants and bars.

The townhouse house consists of about 196m², plus outside space including a large rooftop terrace and a cosy patio with a splendid 16 smq pool, giving you real luxury lifestyle while enjoying the splendid area of an old fishermen's village.

Featuring 3 double bedrooms, including the master with en suite bathroom and walk-in wardrobe, open plan kitchen, living and dining area, an patio on living area level with pool and a stunning roof terrace with views to the sea.

The property is equipped with Gaggenau appliances, SONOS Loudspeaker System, Unifi High End Wifi System, sauna, laundry area, fitted wardrobe, energy efficient heating system.

NUEVA CASA DE LUJO EN EL MOLINAR CON TERRAZA, VISTAS AL MAR Y PISCINA

Seguro que la zona del Molinar es una de las más cotizadas de Mallorca. Muy cerca del aeropuerto, a sólo un salto de Palma se disfruta de la tranquilidad a pocos metros de la playa de arena del Molinar.

Esta increíble propiedad nueva está a sólo 5 minutos a pie del fantástico puerto de nueva construcción. Toda la zona está llena de increíbles restaurantes y bares.

La casa adosada consta de unos 196m², además de espacio exterior, incluyendo una gran terraza en la azotea y un patio acogedor con una espléndida piscina de 16 smq, que le da un estilo de vida de lujo real mientras disfruta de la espléndida zona de un antiguo pueblo de pescadores.

Dispone de 3 dormitorios dobles, incluyendo el principal con baño en suite y vestidor, cocina americana, salón y comedor, un patio en el nivel de la sala de estar con piscina y una impresionante terraza en la azotea con vistas al mar.

La propiedad está equipada con electrodomésticos Gaggenau, sistema de altavoces SONOS, sistema Wifi de alta gama Unifi, sauna, lavadero, armario empotrado, sistema de calefacción de bajo consumo.

NEUES LUXUSHAUS IN EL MOLINAR MIT DACHTERRASSE, MEERBLICK UND POOL

Die Gegend um Molinar ist mit Sicherheit eine der begehrtesten auf Mallorca. Ganz in der Nähe des Flughafens, nur einen Sprung nach Palma genießen Sie Ruhe nur wenige Meter entfernt vom Sandstrand von Molinar.

Diese erstaunliche neue Eigenschaft es nur 5 Minuten zu Fuß entfernt von der fantastischen neuen Hafen gebaut. Die ganze Gegend ist voll von erstaunlichen Restaurants und Bars.

Das Stadthaus hat eine Fläche von 196m², plus Außenbereich mit einer großen Dachterrasse und einem gemütlichen Innenhof mit einem herrlichen 16 qm großen Pool, der Ihnen einen luxuriösen Lebensstil bietet, während Sie die herrliche Gegend eines alten Fischerdorfes genießen.

Das Haus verfügt über 3 Doppelschlafzimmer, darunter das Hauptschlafzimmer mit eigenem Bad und begehbarem Kleiderschrank, eine offene Küche, einen Wohn- und Essbereich, eine Terrasse auf der Ebene des Wohnbereichs mit Pool und eine atemberaubende Dachterrasse mit Blick auf das Meer.

Die Immobilie ist mit Gaggenau-Geräten, SONOS-Lautsprechersystem, Unifi-High-End-Wifi-System, Sauna, Waschküche, Einbauschränke, energieeffizientes Heizsystem ausgestattet.

C-799 B



bconnected[®]

C-799 B



bconnected[®]

C-799 B



bconnected®

C-799 B



1 PLANTA BAJA
MEDIDAS APROXIMADAS

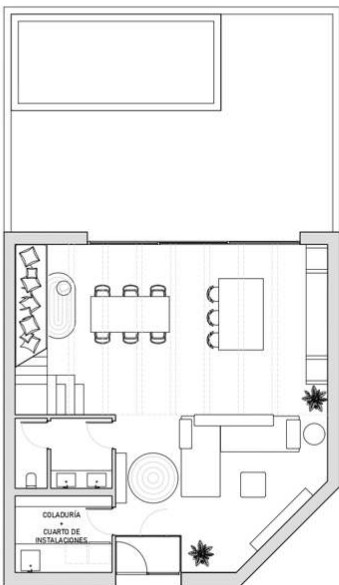

2 PRIMERA PLANTA
MEDIDAS APROXIMADAS

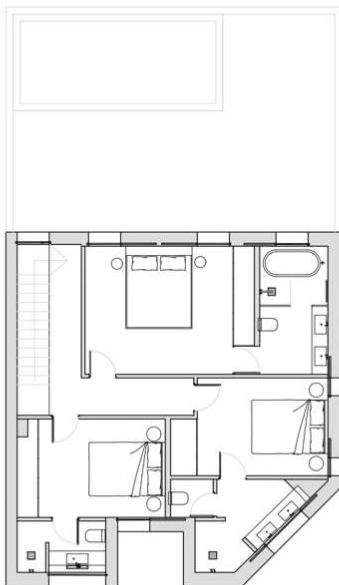

3 CUBIERTA
MEDIDAS APROXIMADAS

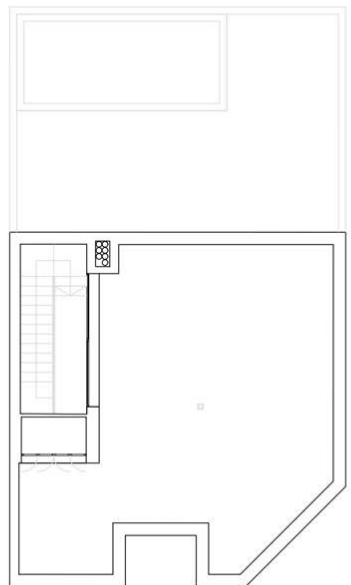

bconnected[®]

C-799 B

PLANTA BAJA MEDIDAS APROXIMADAS

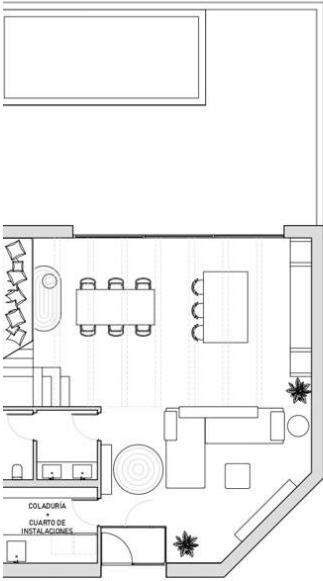

2 RENDER 1



3 RENDER 2



2 RENDER 3



3 RENDER 4



PRIMERA PLANTA MEDIDAS APROXIMADAS



2 RENDER 1



3 RENDER 2



4 RENDER 3



5 RENDER 4



6 RENDER 5



bconnected[®]

C-799 B

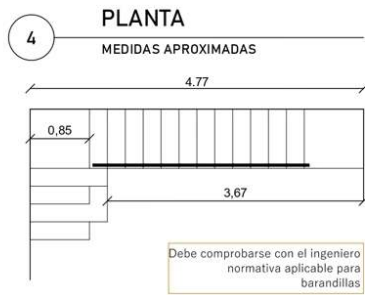
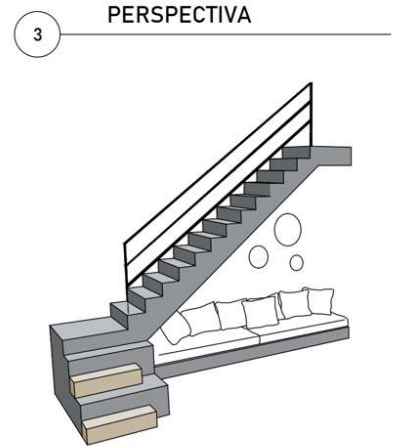
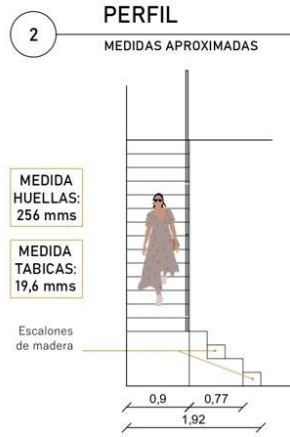
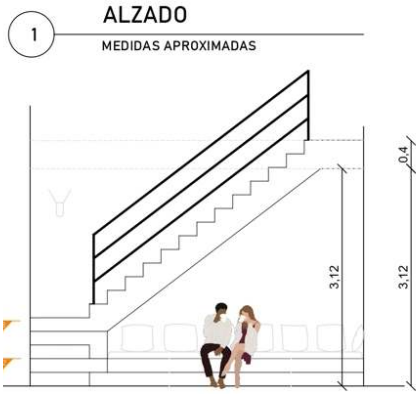

COME VISIT US!



BCONNECTED HEADQUARTER

Plaça Espanya 3, 07181 Portals Nous, Calvia

+34 971 221 066 / realestate@bconnectedmallorca.com

www.bconnectedmallorca.com



bconnected®